



CUSTOMER	
ATTENTION 1	2M STARVIS™ CMOS
ATTENTION 2	IP, 42x42mm
MODEL	PZM-AA92TNR
CODE NO	

HD IP Color Camera Module

SPECIFICATIONS

DEC. 12 2019

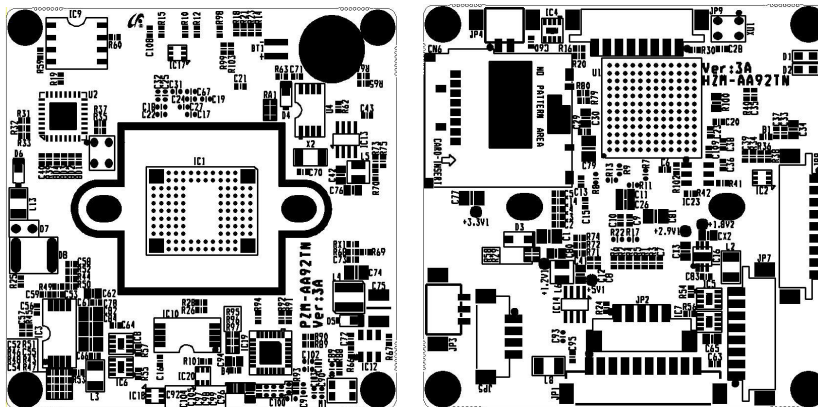

P&A Corporation



Table of Contents

- Revision History

1. Features	4
2. Applications & Information	
2-1. General Specifications & Functions	6
2-2. Block Diagram	8
2-3. I/O Interface Specifications	
2-3-1. I/O Circuit	9
2-3-2. I/O Specifications	10
2-3-3. PCB Layout	13
2-4. PCB Outline Dimensions	14
3. Packing Information	16
4. Reference Data Sheet	
5-1. OLPF(Optical Low Pass Filter) Specifications	
5-1-1. OLPF for general lens	17
5-1-2. OLPF for general lens-2	18
5-1-3. OLPF for TDN lens	18
5-1-4. OLPF for Night Vision	19
5-2. I/O Connector Specifications	20



- Revision History

Date	Version	Description
Mar.02 2018	0A	Establishment
Dec.12 2019	0B	Change Specification



1. Features

■ 1/2.8" STARVIS™ 2MEGA SONY CMOS

High definition 12-bit digital image signals offering 2 mega pixels are obtained with high speed of 120 fps (LVDS output I/F) and with low power consumption. High sensitivity, low dark current and no smear are achieved through the adoption of R, G and B primary color mosaic filters. This chip features an electronics shutter with variable charge-integration time.

■ with 2-Motor Lens

- **Auto Focus** : When the camera zooms IN / OUT, the focus is then automatically engaged. In addition, even when the Day & Night performed, and the focus then automatically engaged.
- **Manual Zoom In/Out** : When the user wants to control the camera more precise zoom and focus, manual control is possible.
- **One Push AF** : While viewing the camera image, when you need to correct the focus, the use of this feature, it is possible to obtain a better image.

■ Eyenix Solution

The EN673 is a H.264/JPEG encoder LSI with a signal processor for a single CMOS color camera. This chip supports primary color CMOS image sensors. In addition to basic camera signal processing functions, it also incorporates an AE/AWB/AF detection circuit and a sync signal generating circuit. It incorporates H.264/JPEG video encoding functions and G.711 audio codec functions, and can generate both video and audio data. A built-in 10/100 M-EtherMAC distributes video and audio data on network like as LAN.

(Applications: Network cameras (Surveillance, SOHO, Home security (wired/wireless)))

■ Camera signal processing

- ◆ Primary color filter de-mosaic
- ◆ On-chip detector for AE/AWB/AF
- ◆ Static/Dynamic white pixel detection and compensation function
- ◆ Programmable gamma correction function
- ◆ Serial interface to control CMOS image sensor

■ Image signal processing

- ◆ 2-D and 3-D Noise Reduction
- ◆ Wide dynamic range signal processing function(WDR)
- ◆ De-fog
- ◆ Lens Shading compensation
- ◆ Moving object detector

■ Dual CPU configuration with a video/audio streaming processing, a hardware control CPU, a video analytics processing and a audio codec



processing.

- ◆ Dual CPU ExRISC™ (for video/audio streaming processing)
 - Instruction cache1,2 : 32kbytes
 - Embedded SRAM(32KB x 4)

■ Multi image encoding function

- ◆ H.264(max.1920x1080p@30frame/s)
- ◆ JPEG Baseline

■ Audio transmit/receive function

- ◆ G.711
- ◆ I-S interface (fixed to 48kHz)
- ◆ On-chip sampling rate converter

■ On-chip 10/100M-EtherMAC(MII/RMII)

■ Video analytics processing support function

- ◆ Background model execution circuit

■ SD/SD-IO interface (2ch) that supports SD card & WiFi(option)



2. Applications & Information

2-1. General Specifications & Functions

[General]

Items	Sub-items	PZM-AA92TNR
Lens	Back Focal Length	2.7~12mm±5%
	2-Motor	Adjust Auto Focus(When zoom in/out)
	Iris	DC iris(Galvanometer)
	TDN	Day & Night(Galvanometer)
I/O	SD Card(Optional)	Max 32G
	Alarm	In 1ch / Out 1ch
	Control	UART0
	AUDIO	In/Out
Power Consumption		DC +12V / T.B.D
Operating Temperature		Absolute : -10°C ~ +50°C
Operating Humidity		Less than 90%
Dimension		42mm x 42 mm x 1.0t

[Camera]

Items	Sub-items	PZM-AA92TNR
CMOS	Device	1/2.8" 2MEGA CMOS
	Total	1945 (H) × 1109 (V)
	Effective	1945 (H) × 1097 (V)
Performance	Horizontal/Vertical Resolution	1100 TV Lines
	Minimum illumination (F1.2, AGC Max) : T.B.D	Color : 0.03 Lux(50IRE) / 0.06 Lux(15IRE) B/W : 0.25 Lux(50IRE) / 0.05 Lux(15IRE)
	S/N Ratio	More than 50dB (AGC off)
	Frame	30fps Full HD
Functions	OSD	Off/On
	Day&Night	Auto/Color/B&W/EXTERN
	ATW	1800 ~ 10500K
	High Speed Shutter	1/60(1/50) ~ 1/135Ksec
	WDR	Off/ON
	Blemish compansation	Auto detection & correction
	BLC	Off/ON
	HLC	Off/ON
	AGC	Max 54dB
	White Balance	ATW, Shade, Clear Sky, Fluorescent Light etc.
	DNR	2D+3DNR
	Motion Detection	Off/ON
	De-Fog	Off/On
	Lens Distortion Compensation	Off/On



[IP(Network)]

Items	Sub-items	PZM-AA92TNR
Video	Compression	H.264(High, Main, Base line profile), MJPEG
	Resolution	1920x1080(Full-HD)
	Frame Rate	Up to 30fps@1920x1080p
	Streaming	Simultaneously H.264 and MJPEG (Triple Streaming) Independent Frame Rate and Bandwidth Control, VBR/CBR Mode
Audio	Streaming	G.711(In/Out)
FTP	Uploading	MJPEG Still Image
Event	In	Onboot/Trigger/Network Loss/Tampering/ <i>Motion</i>
	Out	E-mail, FTP
Security		Multi User Authority, IP Filtering, HTTPS
Network Time Sync		Synchronize Computer/NTP Server, Manual
Software Reset		Restart, Reset, Factory Default
Auto Recovery		Backup, Restore
Remote Upgrade		Using Web Browser
Protocols		TCP/IP, UDP, IPv4/v6, HTTP, HTTPS, FTP, UPnP, RTP, RTSP, RTCP, DHCP, ARP, Zeroconf
Client Software		Built-In Web, ONVIF Compatible 3rd Party VMS
Max. User Connection		10 Users
SDK Support		API, ONVIF Profile S Compliant



2-2. Block Diagram

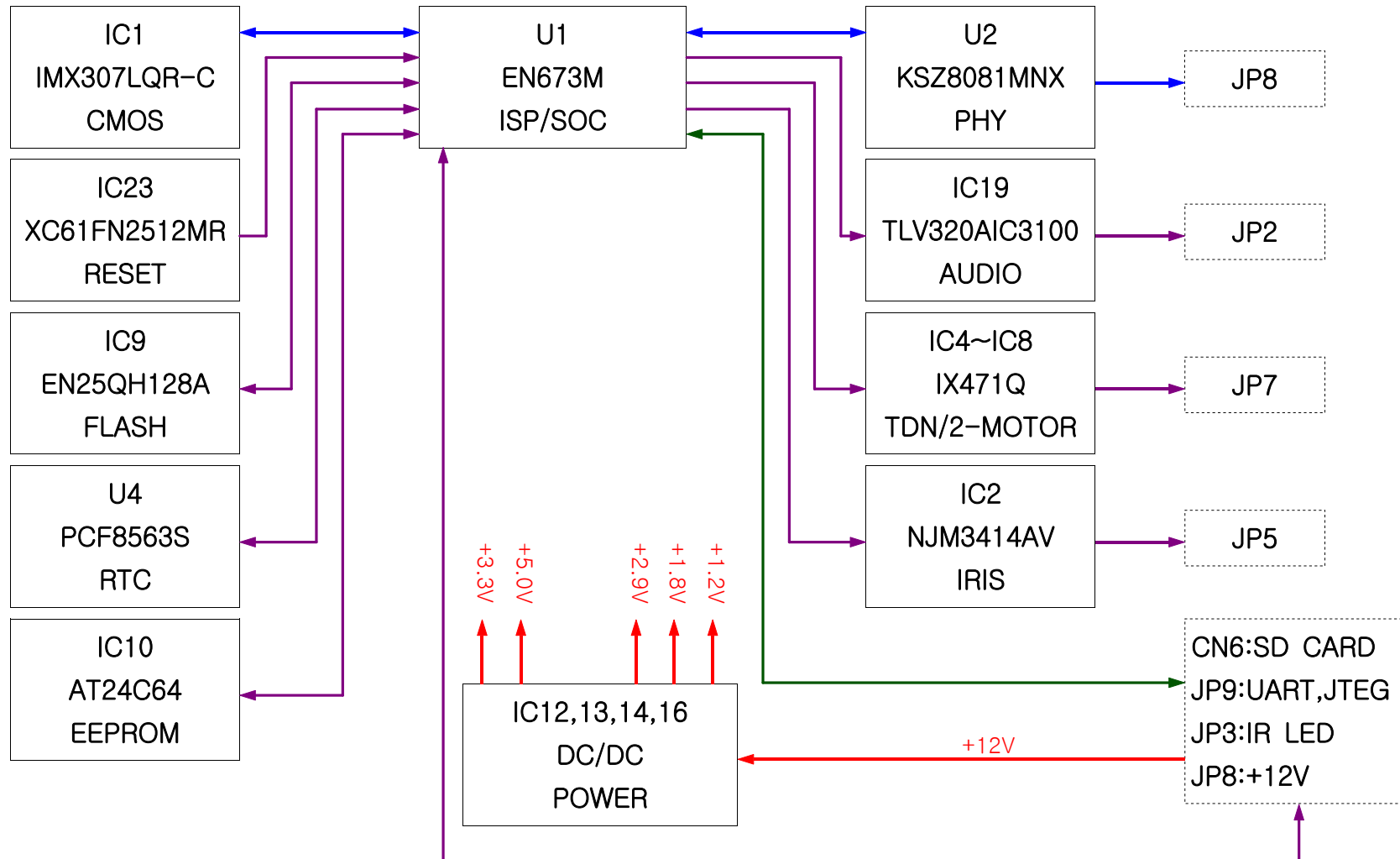



2-3. I/O Interface Specifications

2-3-1. I/O Circuit

COMMUNICATIONS

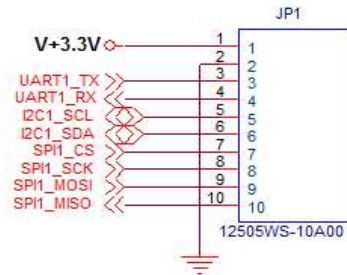

AUDIO & ALARM

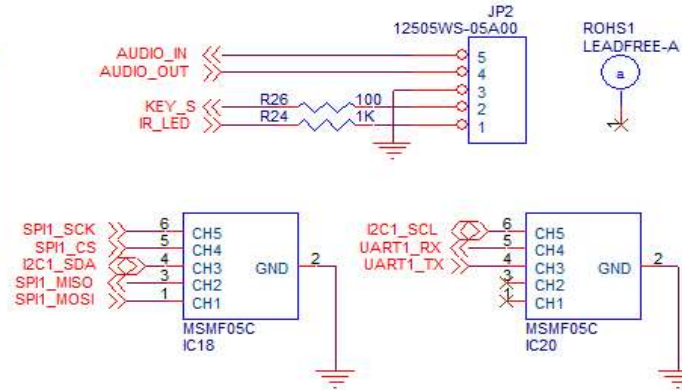

IR_LED

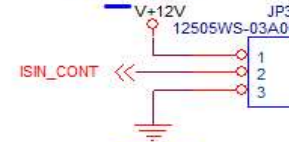

TDN

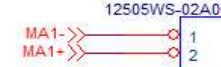

DC_IRIS

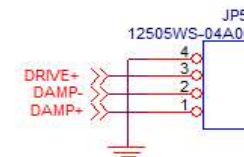

UPGRDE & CONSOLE

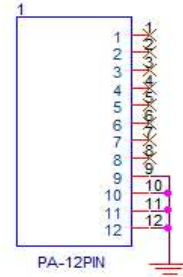
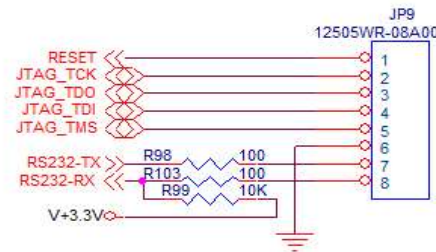

ZOOM & FOCUS

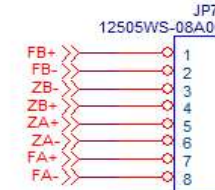

LAN & POWER

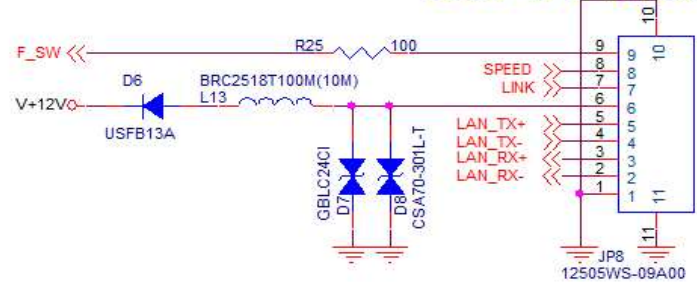



2-3-2. I/O Specifications

Bottom View

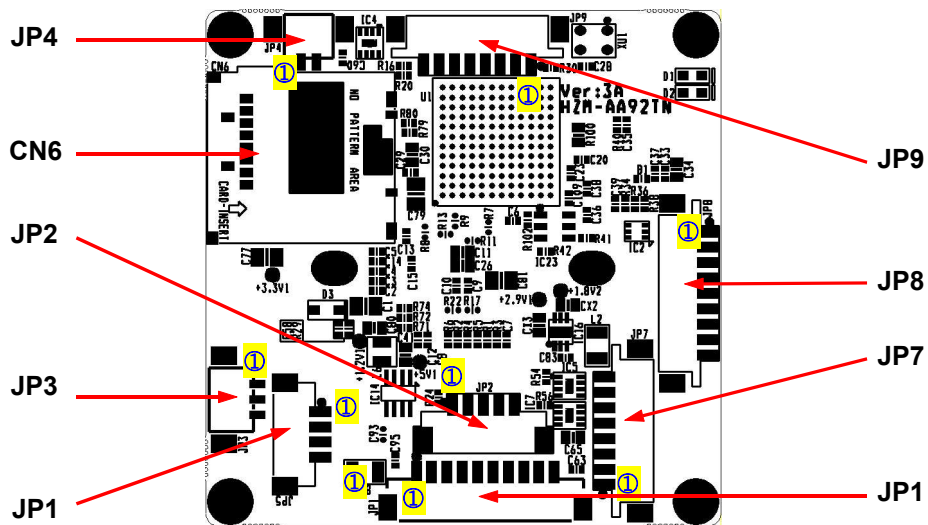

① CN6 : SD Card

② JP2 : Audio/Ararm Connector

Pin NO	Pin Name	Description	Normal	Active	I/O
1	AUDIO_IN	CAMERA MIC Input	~	~	I
2	AUDIO_OUT	Audio Output	~	~	O
3	GND	Ground	-	-	-
4	KEY_S	AD Key input	3V	0~2.6V	I
5	IR_LED	IR LED Control Output	Open	0V	O

Yeonho Electronics, 12505WS-05A00

③ JP4 : Day & Night Motor Control Connector

Pin NO	Pin Name	Description	Normal	Active	I/O
1	MA-	Day & Night Motor Drive + Output	Open	5V/0V	O
2	MA+	Day & Night Motor Drive - Output	Open	0V/5V	O

Yeonho Electronics, 12505WS-02A00

④ JP3 : Extra DC+12V & D&N Control Input

Pin NO	Pin Name	Description	Normal	Active	I/O
1	V+12V	Extra DC+12V Output(Use IR LED Board)	DC+12V	DC+12V	O
2	D/N-SELI	Day & Night Control Input	Open	0V	O
3	GND	Board GROUND	-	-	-

Yeonho Electronics, 12505WS-03A00



⑤ JP5 : Auto Iris Lens Control Connector

Pin NO	Pin Name	Description	Active	I/O
1	DAMP+	DC Iris Damping Motor +	DAMP+	O
2	DAMP-	DC Iris Damping Motor -	DAMP-	O
3	DRIVE+	DC Iris Motor Drive	DRIVE+	O
4	GND	Board GROUND	-	-
Yeonho Electronics, 12505WS-04A00				

⑥ JP9 : Upgrade & Console

Pin NO	Pin Name	Description	Normal	Active	I/O
1	RESET	System Reset	3.3V	0V	I
2	JTEG_TCK	Upgrade Clock	3.3V	0/3.3V	O
3	JTEG_TDO	Upgrade Output	3.3V	0/3.3V	O
4	JTEG_TDI	Upgrade Input	3.3V	0/3.3V	I
5	JTEG_TMS	Upgrade Select	3.3V	0/3.3V	O
6	GND	Ground	-	-	-
7	RS232_TX	UART Console Output	3.3V	0/3.3V	O
8	RS232_RX	UART Console Input	3.3V	0/3.3V	I
Yeonho Electronics, 12505WS-08A00					

⑦ JP8 : DC+12V & Network Output

Pin NO	Pin Name	Description	Normal	I/O
1	GND	Ground	-	-
2	RD-(TD-)	Physical receive or transmit signal(-differential)	1V p-p(10/100M)	I/O
3	RD+(TD+)	Physical receive or transmit signal(+differential)	1V p-p(10/100M)	I/O
4	TD-(RD-)	Physical transmit or receive signal(-differential)	1V p-p(10/100M)	O/I
5	TD+(RD+)	Physical transmit or receive signal(+differential)	1V p-p(10/100M)	O/I
6	V+12V	Main Power Input	DC+12V±10%	P
7	LINK	RJ-45 Link LED Output	Blink	O
8	SPEED	RJ-45 Speed(10/100M) LED Output	0V	O
9	F_SW	Factory Reset Switch	3.3V	I
Yeonho Electronics, 12505WS-09A00				

⑧ JP5 : Zoom/Focus Motor Connector

Pin NO	Pin Name	Description	Normal	Active	I/O
1	FA-	Focus A- Motor Drive Signal	Hi-Z	3.3V/0V	O
2	FA+	Focus A+ Motor Drive Signal	Hi-Z	3.3V/0V	O
3	ZA-	Zoom A- Motor Drive Signal	Hi-Z	3.3V/0V	O
4	ZA+	Zoom A+ Motor Drive Signal	Hi-Z	3.3V/0V	O
5	ZB+	Zoom B+ Motor Drive Signal	Hi-Z	3.3V/0V	O
6	ZB-	Zoom B- Motor Drive Signal	Hi-Z	3.3V/0V	O
7	FB-	Focus B- Motor Drive Signal	Hi-Z	3.3V/0V	O
8	FB+	Focus B+ Motor Drive Signal	Hi-Z	3.3V/0V	O
Yeonho Electronics, 12505WS-08A00					



2-3-3. PCB Layout

<TOP VIEW>

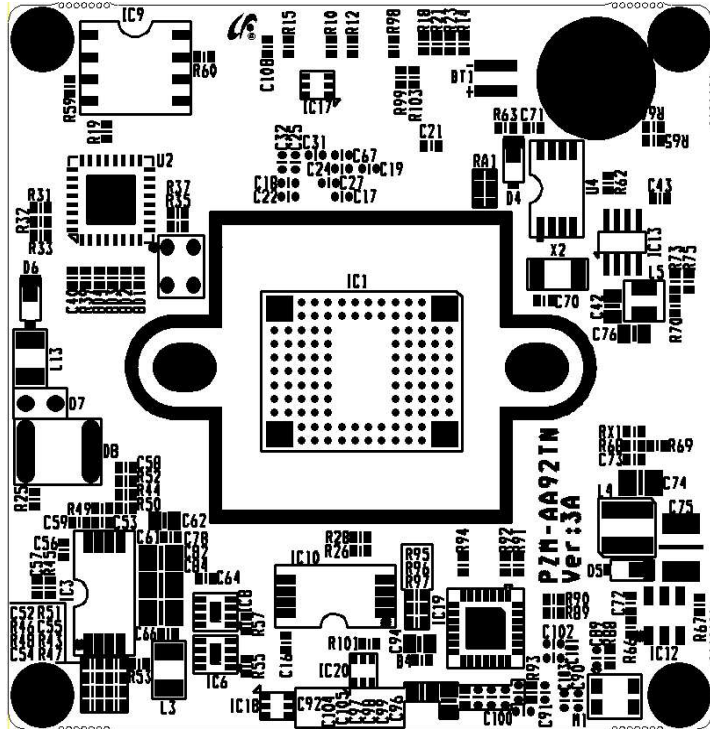

<BOTTOM VIEW>

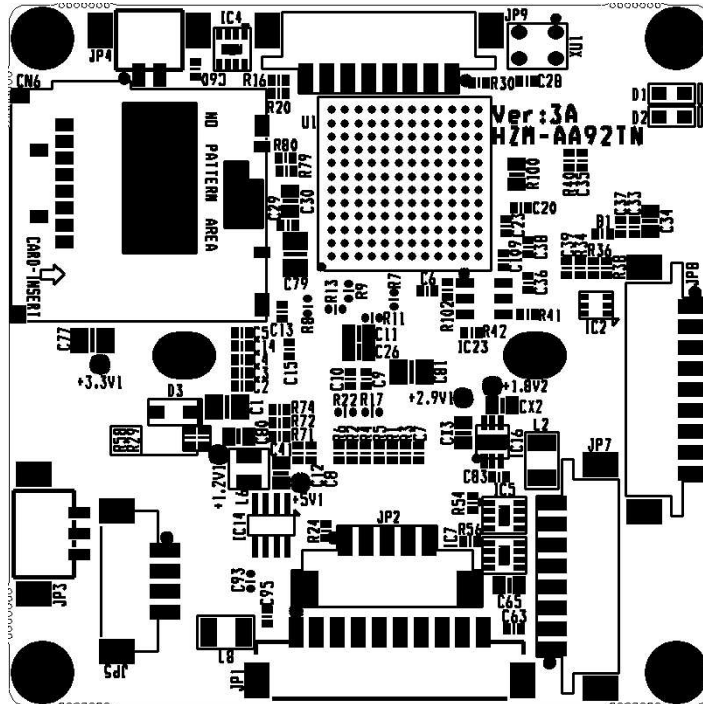



2-4. PCB Outline Dimensions

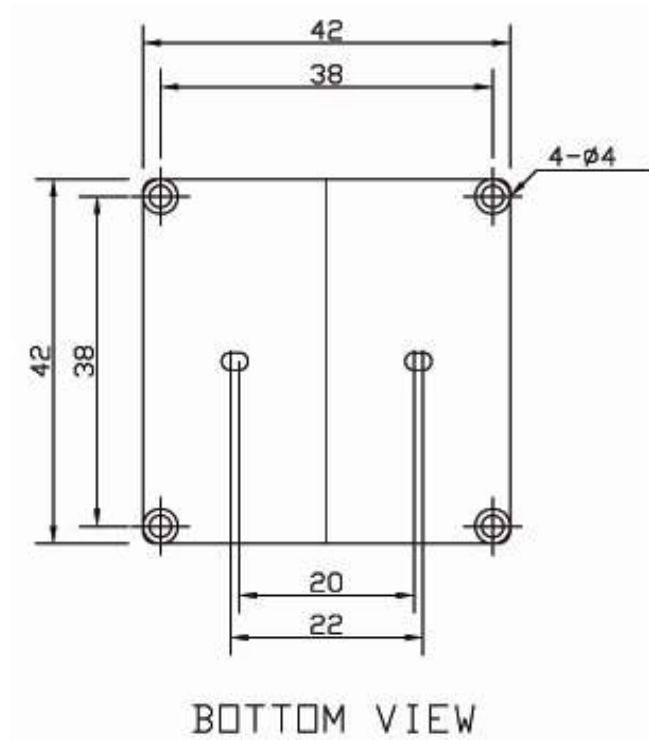
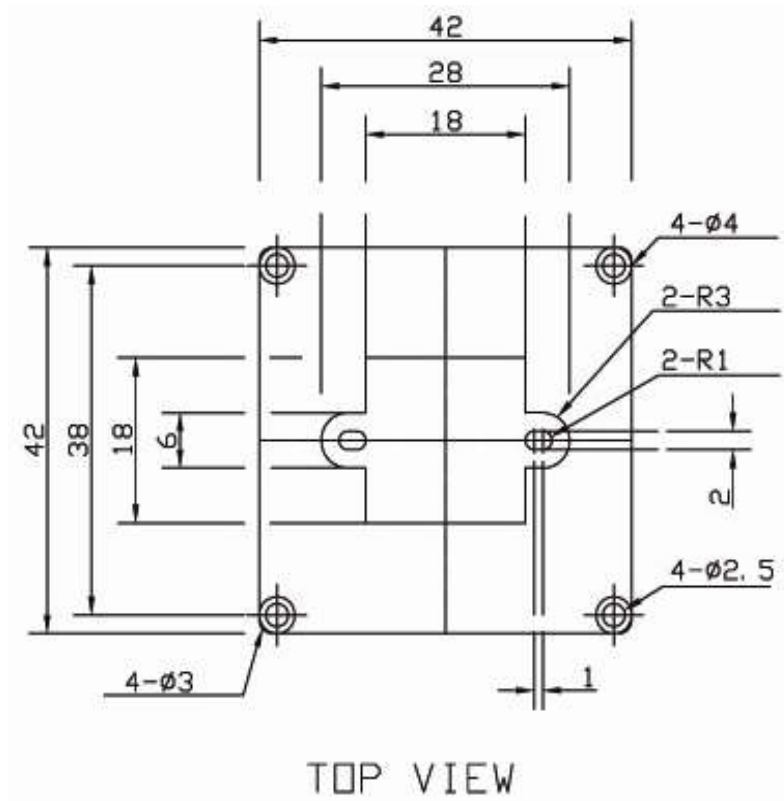



4. Packing Information

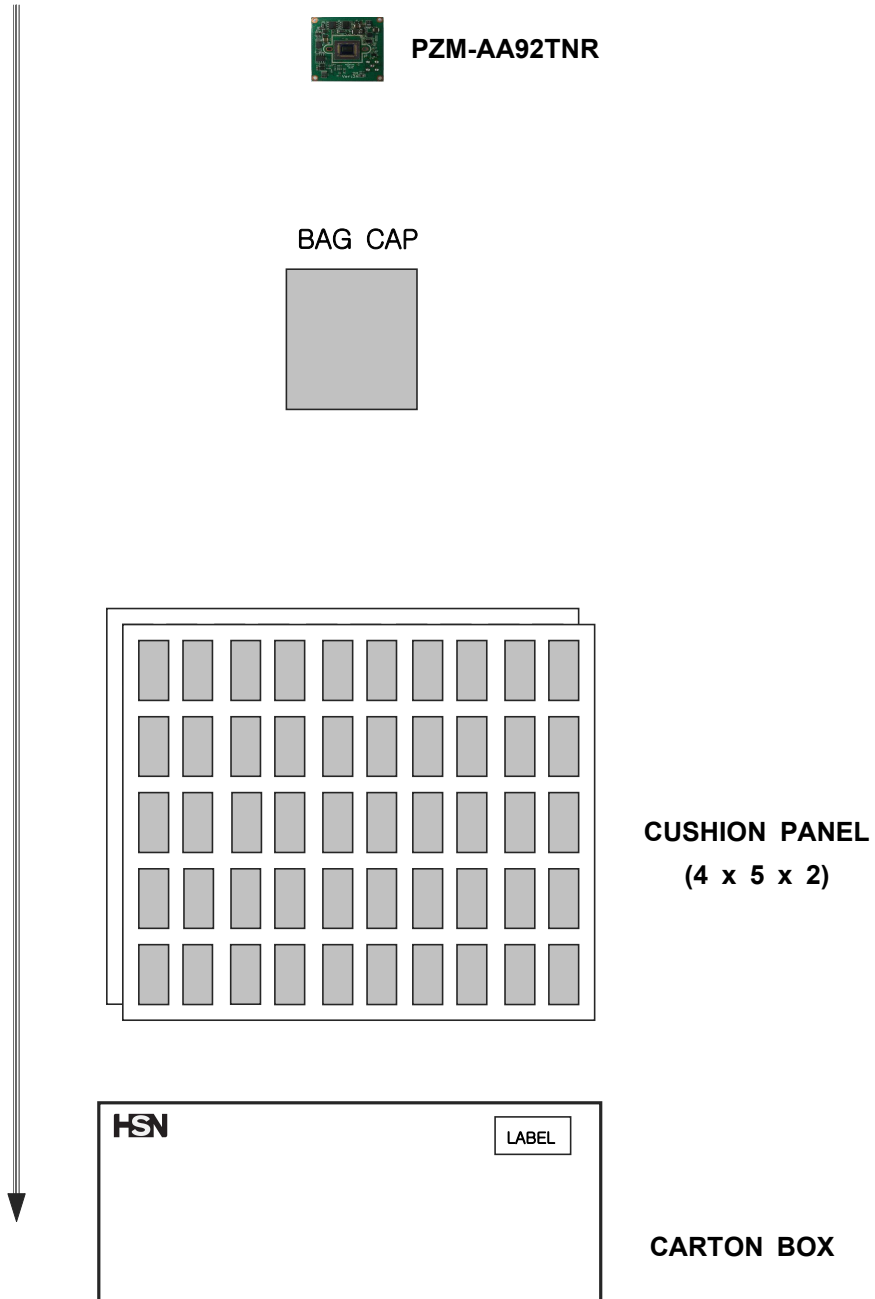



5. Reference Data Sheet

5-1. OLPF(Optical Low Pass Filter) Specifications

5-1-1. OLPF for general lens-1(OLPF Manufacturer : KDS)

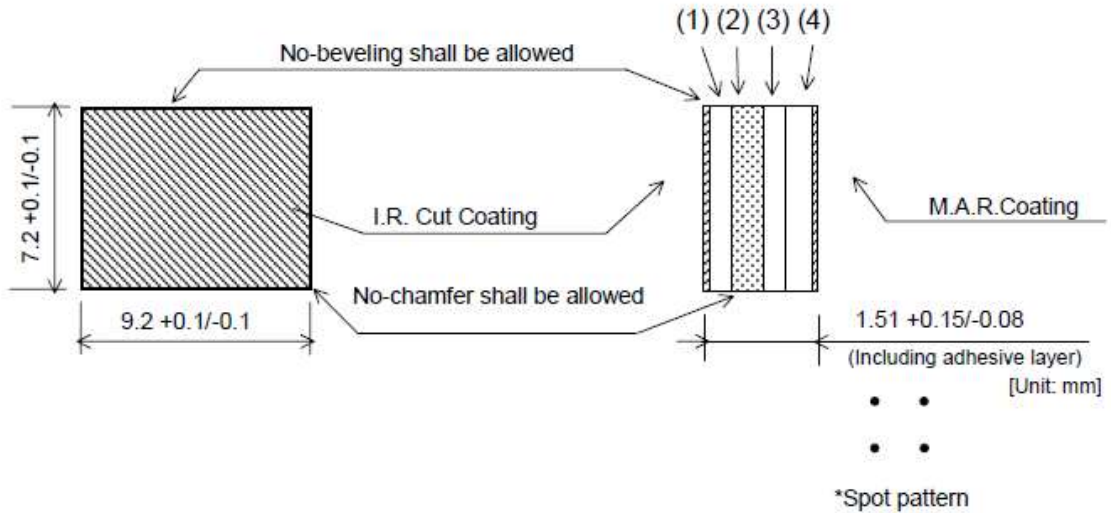

No.	Item	Thickness (mm)	Orientation (degree)	Rotating Angle (degree)	Note
(1)	Double Refraction Plate	0.31 +0.02/-0.01	45 +1/-1	0 +1/-1	
(2)	Infrared Absorbing Glass	0.54 +0.03/-0.03	-	-	C5000(HOYA) or NF50(AGC)
(3)	Wave Plate	0.35 +0.03/-0.03	0 +1/-1	45 +1/-1	
(4)	Double Refraction Plate	0.31 +0.02/-0.01	45 +1/-1	90 +1/-1	

*Rotating angle of parts No. (3) is possible event by -45 +1/-1 degree.

Wavelength (nm)	400-450	450-500	500-550	655+15/-15	720-750	750-1050	1050-1100
Transmission Rate (%)	83min.(Avg.)	87min.(Avg.)	84min.(Avg.)	50	3max.	1max.(Avg.)	5max.
Ripple (%)	73min.	82min.	79min.	-	-	2max.	-

(Spectral characteristics of Optical Low Pass Filter)



5-1-2. OLPF for general lens-2(OLPF Manufacturer : Max Gain)

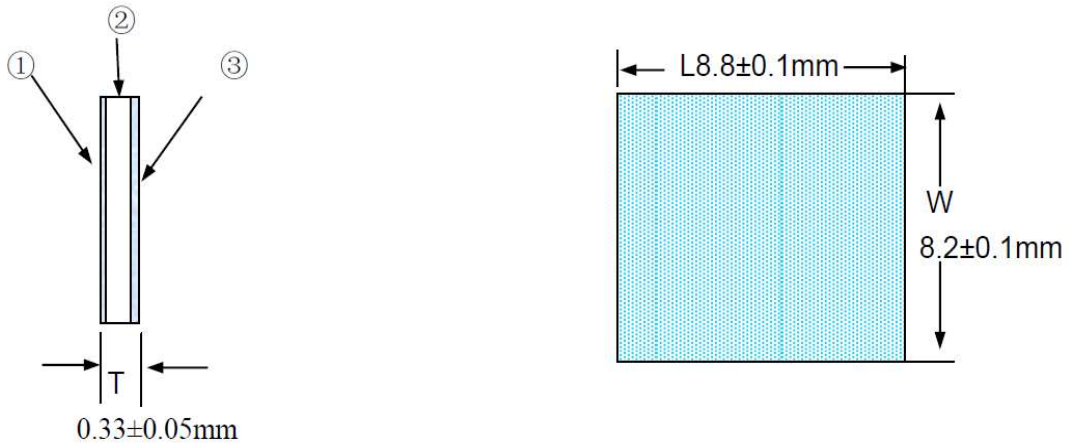

Part No	Part Name	Dimension(mm)			Orientation Angle	Rotation Angle	Flatness	Para.
		L	W	T				
①	IR Coating							
②	Double refractive plate	8.8±0.1	8.2±0.1	0.33±0.05	45	0	3N	2'
③	AR Coating							

Wave Length(nm)	Transmission (%)
400nm	>75%
450~600nm	>80%
645 ± 10nm	=50%
700nm	<5%
1100nm	<15%

5-1-3. OLPF for TDN lens(OLPF Manufacturer : Max Gain)

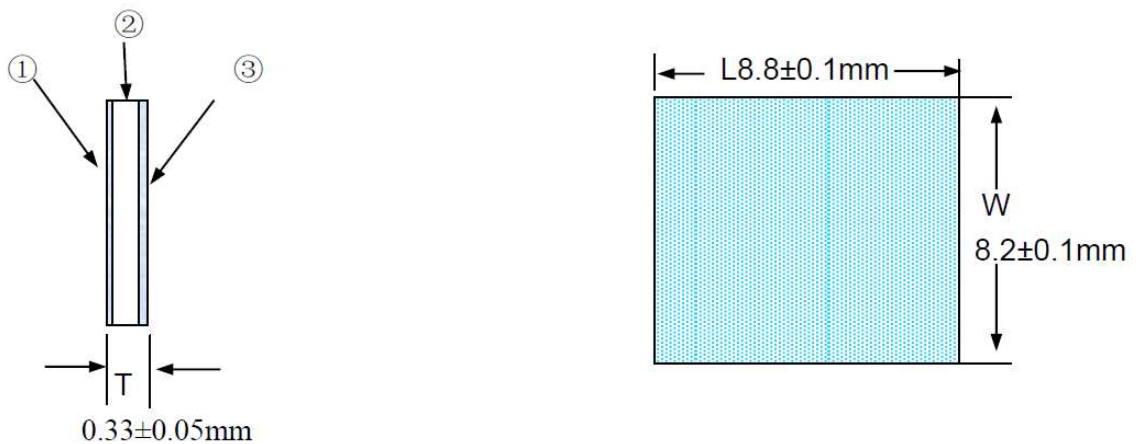





Part No	Part Name	Dimension(mm)			Orientation Angle	Rotation Angle	Flatness	Para
		L	W	T				
①	AR Coating							
②	Double refractive plate	8.8±0.1	8.2±0.1	0.33±0.05	45	0	3N	2'
③	AR Coating							

Wave Length(nm)	Transmission (%)
420~1100nm	>96%

5-1-4. OLPF for Night Vision(OLPF Manufacturer : Max Gain)

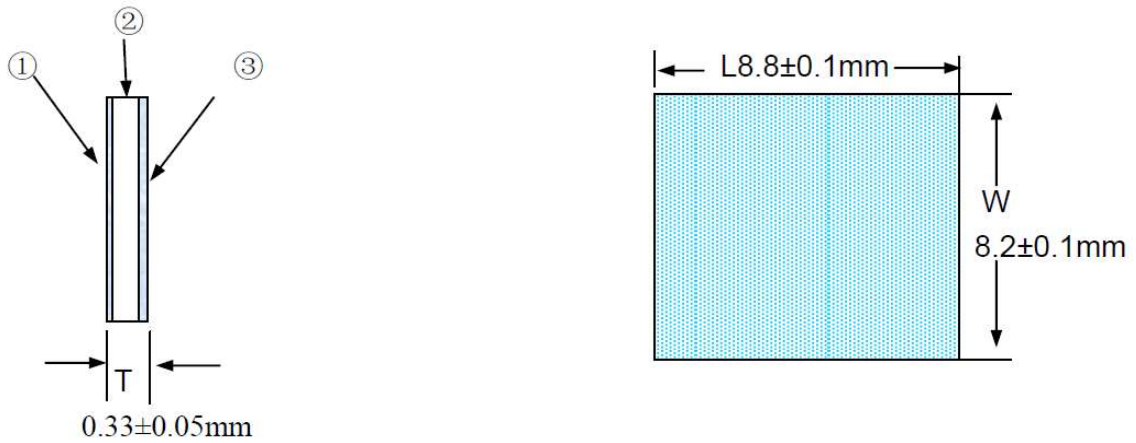

Part No	Part Name	Dimension(mm)			Orientation Angle	Rotation Angle	Flatness	Para
		L	W	T				
①	Night vision Coating							
②	Double refractive plate	8.8±0.1	8.2±0.1	0.33±0.05	45	0	3N	2'
③	AR Coating							



Wave Length(nm)	Transmission (%)
400-420	>75%
421-620	>85%
645±10	50%
700-750	<3%
815±15	50%
850	>80%
900-1100	<20%

5-2. I/O Connector Specifications

5-2-1. 12505WS-XXA00 Series

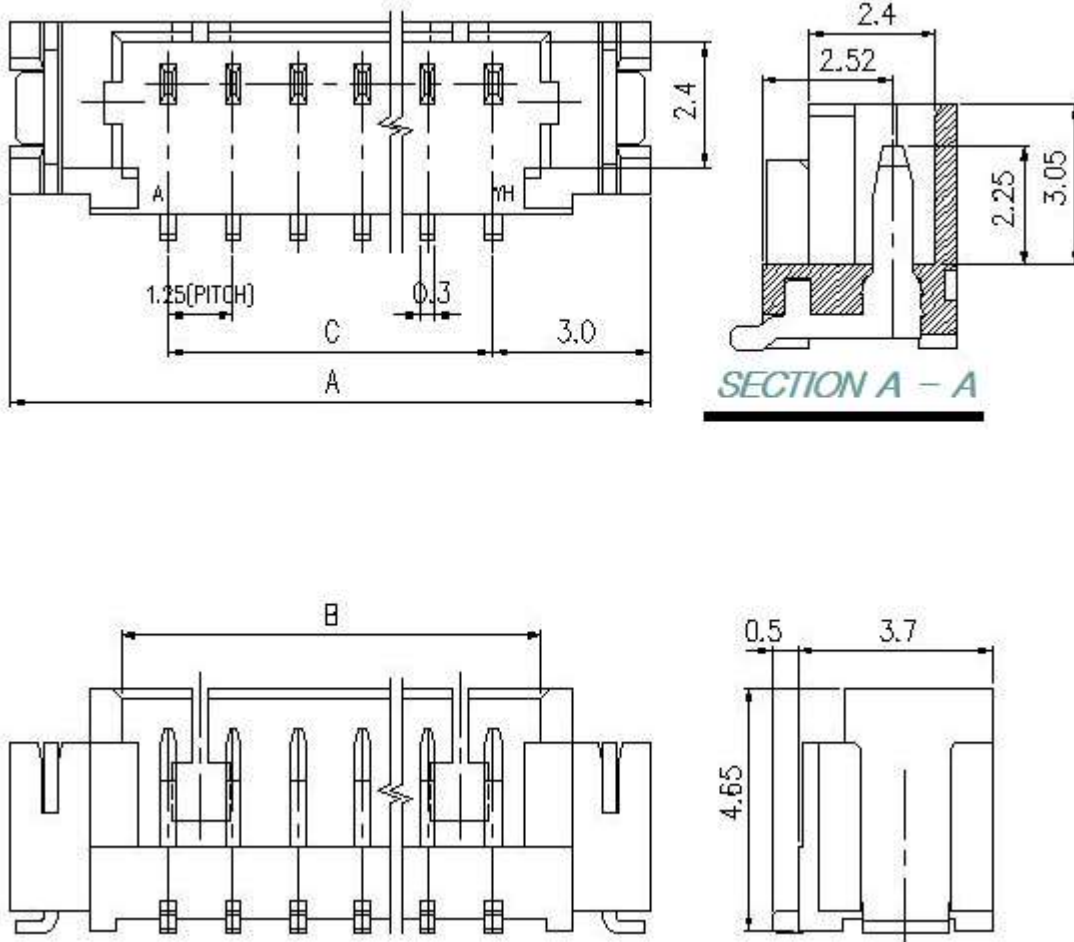



Available Pin

PARTS NO.	A	B	C
12505WS-02	7.25	3.05	-
12505WS-03	8.50	4.30	2.50
12505WS-04	9.75	5.55	3.75
12505WS-05	11.00	6.80	5.00
12505WS-06	12.25	8.05	6.25
12505WS-07	13.50	9.30	7.50
12505WS-08	14.75	10.55	8.75
12505WS-09	16.00	11.80	10.00
12505WS-10	17.25	13.05	11.25
12505WS-11	18.50	14.30	12.50
12505WS-12	19.75	15.55	13.75
12505WS-13	21.00	16.80	15.00
12505WS-14	22.25	18.05	16.25
12505WS-15	23.50	19.30	17.50

Specification

ITEM	SPEC
Voltage Rating	AC/DC 125V
Current Rating	AC/DC 1A
Operating Temperature	-25℃~+85℃
Contact Resistance	30mΩ MAX
Withstanding Voltage	AC250V/1min
Insulation Resistance	100MΩ MIN
Applicable Wire	-
Applicable P.C.B	0.8 ~ 1.6mm
Applicable FPC/FFC	-
Solder Height	0.15mm
Crimp Tensile Strength	-
UL FILE NO	E108706